

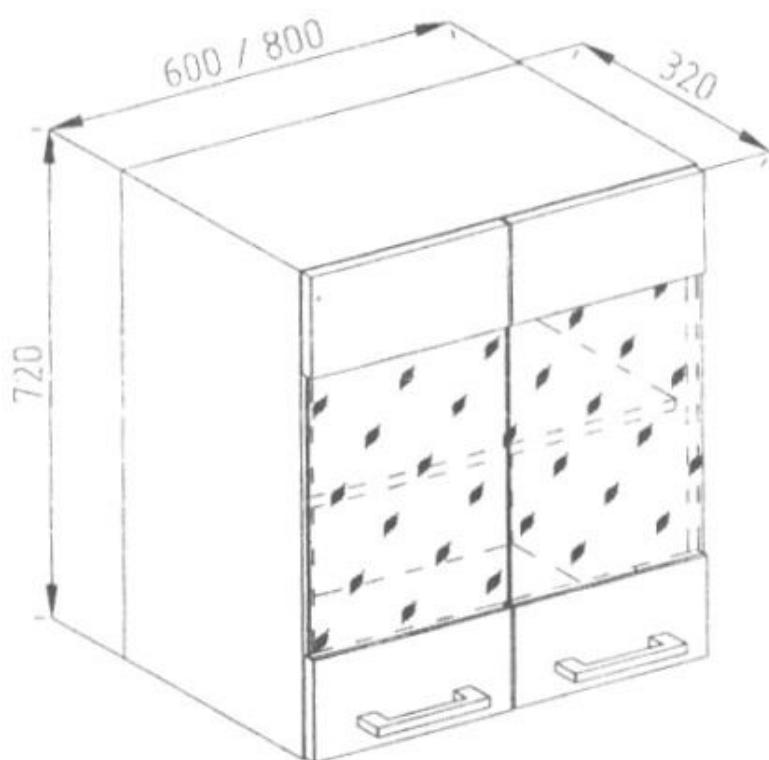

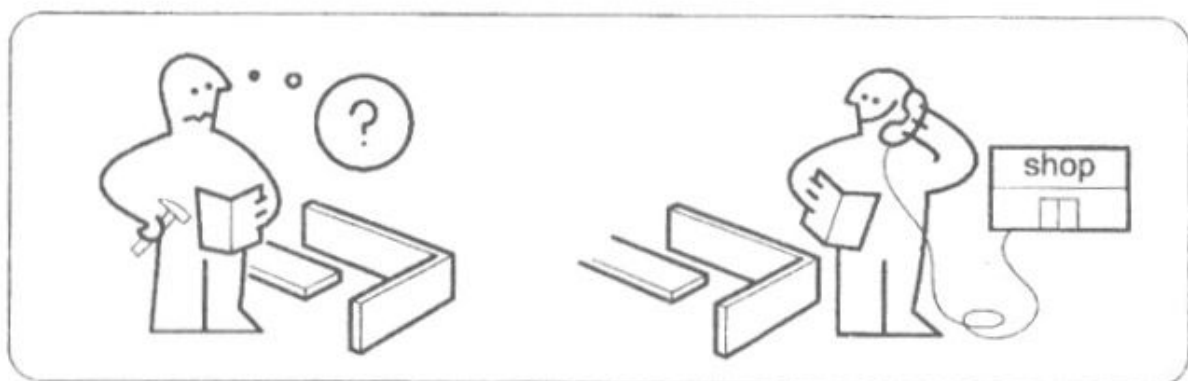

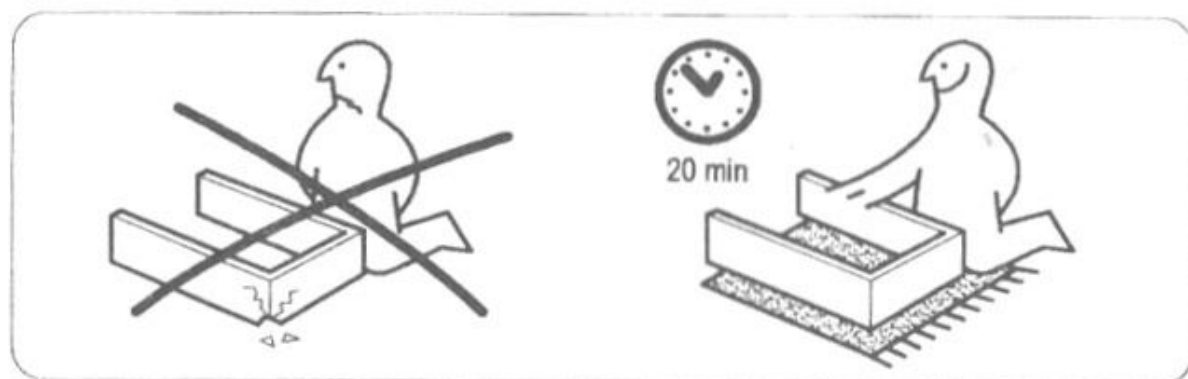

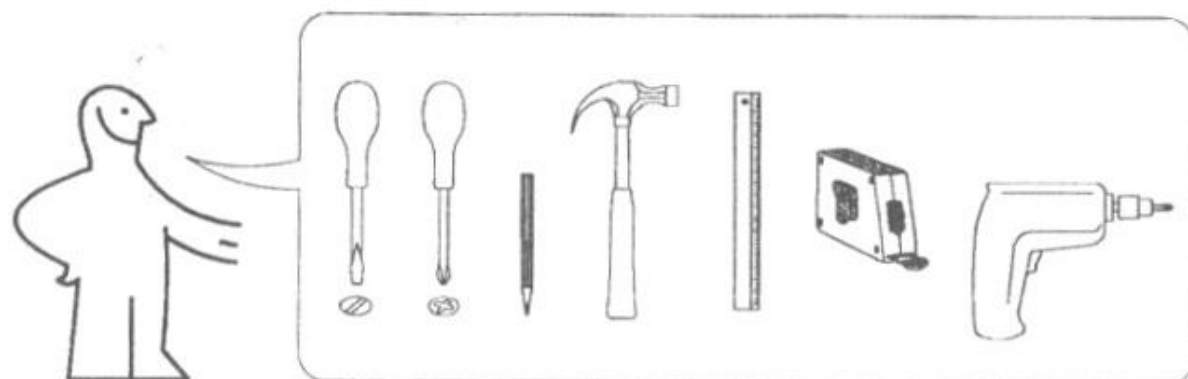









MARTHA

B 60 Cк / B 80 Cк

U 60 GL / U 80 GL

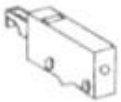



 (A1) 8*30mm x12	 (B) \varnothing 12mm x12	 (B1) 6,3*50mm x12
 (E8) 4*16mm x8	 (E11) 4*30mm x8	 (E13) 4*40mm x4
 (E20) 6*60mm x4	 (F1) 6,3*13mm x8	 (H6) 10*50mm x4
 (I8) x2	 (L1) x4	 (Q1) 1,4*25MM 0.01kg
 (N1) x2	 (O4) x2	 (P1) x1
 (U3) x4		

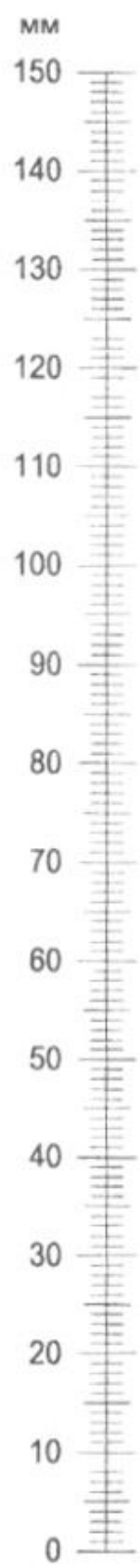

№	a*b		№=...
	B 60 Ck (U 60 GL)	B 80 Ck (U 80 GL)	
1L	720x300	720x300	1
1R	720x300	720x300	1
2	567x300	767x300	2
3	567x300	767x300	1
4L	296x716	396x716	1
4R	296x716	396x716	1
5	596x357	796x357	1
6	596x357	796x357	1

Martha

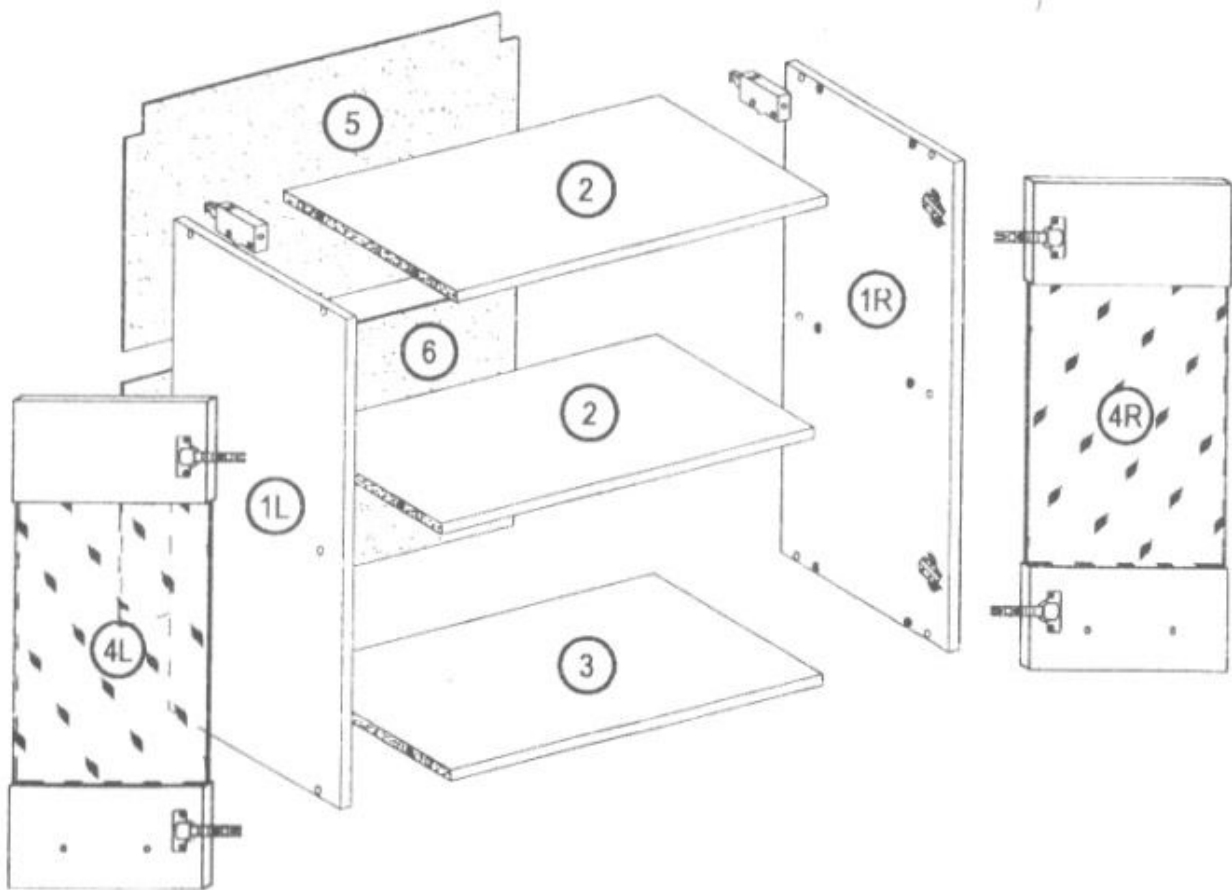

1

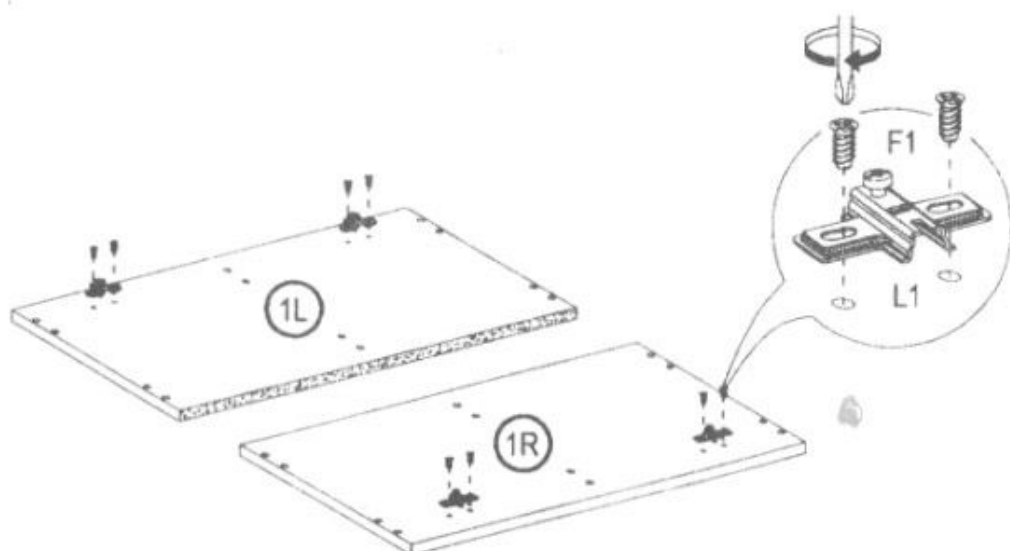
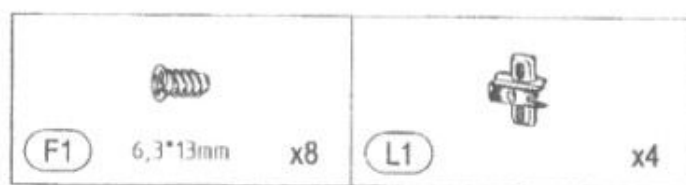

2

